





- 额定电流最高达 50A
Rated currents up to 50A
- 通用紧凑型滤波器适用小空间
General purpose and compact filtering performance for space saving
- 适用于星形和三角形的电源网络
Equally suitable for star and delta power networks
- 安规认证: 
Approval: 

特点 Features

- 紧凑，通用三相四线滤波器
Compact, robust, general purpose three phase four lines filter
- 通用、小巧、方便安装
General purpose, compact, easy for installation and use

应用 Application

- 工业设备、其它需四线的电源设备
Industrial equipment and other general purpose power equipments which use four lines White goods, single phase industrial equipments, power supply systems and controls

技术参数 Technical Data

额定电压 Rated Voltage	380/440VAC
工作频率 Operation Frequency	50/60Hz
额定电流 Rated Current	3-50A
耐压测试 Hi-pot Test	1750VDC, 2 sec (线对线 Line to Line) 2650VDC 2sec (线对地 Line to Ground)
气候类别 Climate Category	25/85/21 (-25°C to +85°C)
设计参考标准 Design corresponding to	UL 1283, CSA 22.2 No. 8 1986, IEC/EN 60939

电路原理图 Electrical Schematic

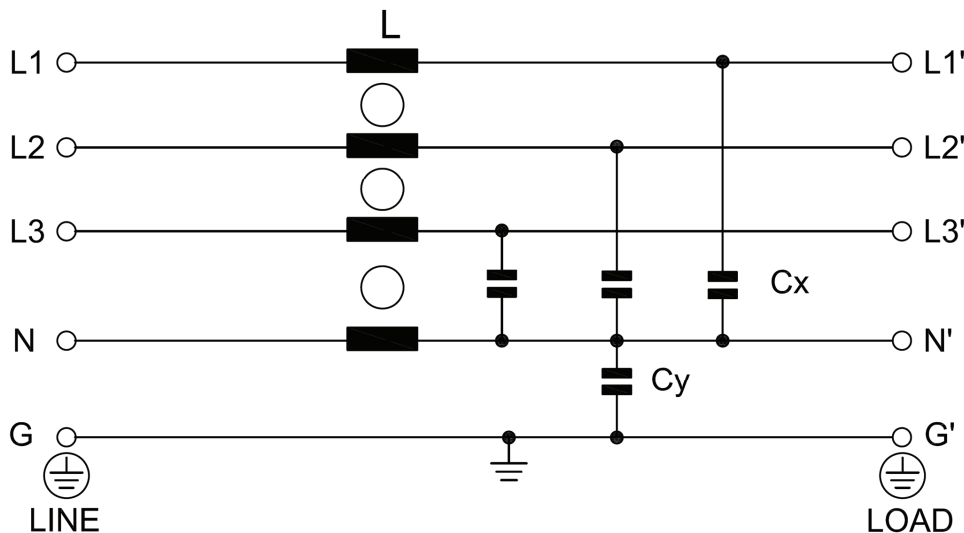

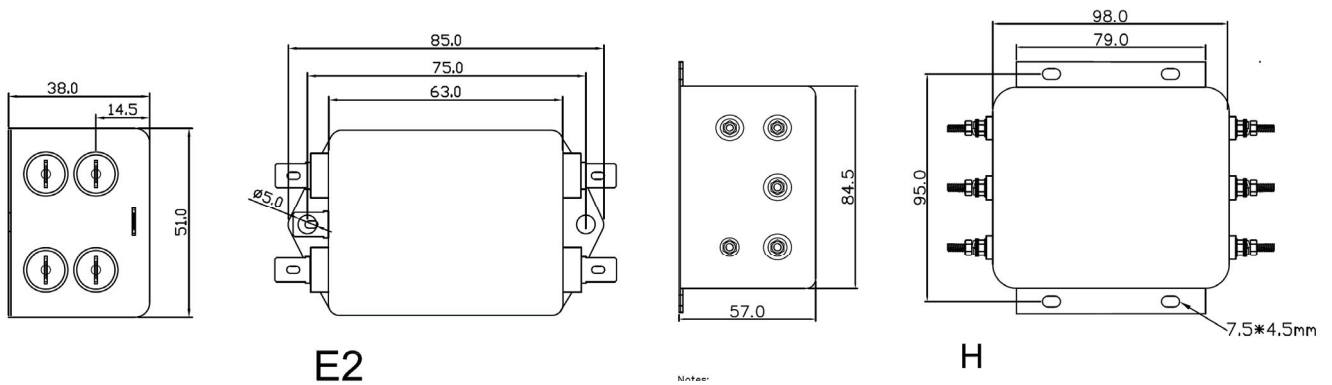

Fig 1

选型表 Type Selection Table

型号 Model	额定电流(A) Rated Current	泄漏电流(≤mA) Leakage Current	电路图 Circuit Diagram	外形尺寸 Dim. Fig.	出线端子方式 Output Connection	
						
DF400-3A-01	3	5.0	Fig 1	E2	Fast on	-
DF400-6A-01	6	5.0	Fig 1	E2	Fast on	-
DF400-10A-01	10	5.0	Fig 1	E2	Fast on	-
DF400-20A-01	20	5.0	Fig 1	E2	Fast on	-
DF400-30A-01	30	5.0	Fig 1	H	-	M6
DF400-40A-01	40	5.0	Fig 1	H	-	M6
DF400-50A-01	50	5.0	Fig 1	H	-	M6

外形尺寸 Outline Dimensions(mm)



插入损耗 Insertion Loss in dB

(50Ω/50Ω 环境下插入损耗 Insertion Loss in dB measured in a 50Ω/50Ω system, as IEC/CISPR No. 17)

A=Differential mode (差模) B=Common Mode(共模)

3A to 6A types

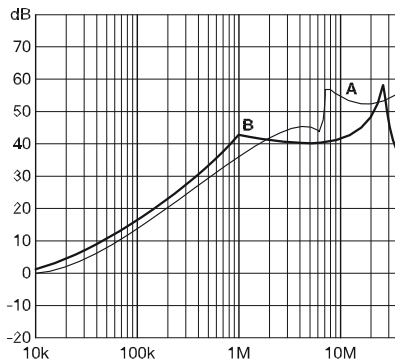

10A to 20A types

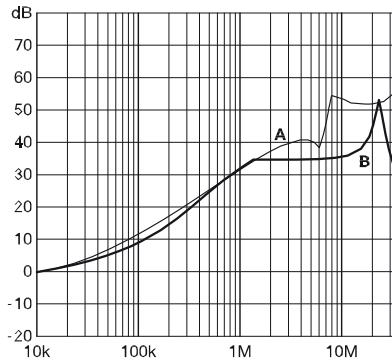

20 to 50A type

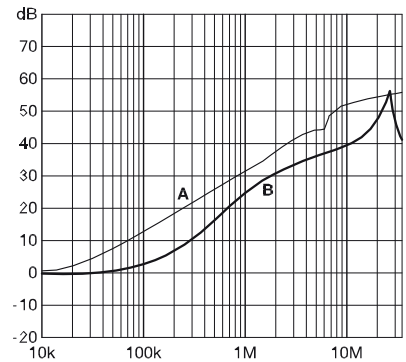

备注：以上规格为公司标准产品，可根据客户产品定制设计产品性能和尺寸外观。

Remark: Customized products are available according to special performance or dimensions requirements

更多产品请登陆官方网站: <http://www.dephir.com>

For more products please go to official website: <http://www.dephir.com>